



KERN & Sohn GmbH

Ziegelei 1
D-72336 Balingen
email: info@kern-sohn.com

Phone: +49-[0]7433- 9933-0
Fax: +49-[0]7433-9933-149
Internet: www.kern-sohn.com

Operating instructions

Medical chair scales

Medical personal scales

KERN MCB, MPT

MCB 300K100NM
MPT 300K100NM
Version 3.3
2018-12
GB



MCB-NM_MPT-NM-BA-e-1833

- D** Weitere Sprachversionen finden Sie online unter www.kern-sohn.com/manuals
- BG** Други езикови версии ще намерите в сайта www.kern-sohn.com/manuals
- DK** Flere sprogudgaver findes på websiden www.kern-sohn.com/manuals
- EST** Muud keeleversioonid leiate Te leheküljel www.kern-sohn.com/manuals
- E** Más versiones de idiomas se encuentran online bajo www.kern-sohn.com/manuals
- GR** Άλλες γλωσσικές αποδόσεις θα βρείτε στην ιστοσελίδα www.kern-sohn.com/manuals
- F** Vous trouverez d'autres versions de langue online sous www.kern-sohn.com/manuals
- LV** Citas valodu versijas atradīsiet vietnē www.kern-sohn.com/manuals
- FIN** Muut kieliversiot löytyvät osoitteesta www.kern-sohn.com/manuals
- LT** Kitas kalbines versijas rasite svetainėje www.kern-sohn.com/manuals
- GB** Further language versions you will find online under www.kern-sohn.com/manuals
- RO** Alte versiuni lingvistice veți găsi pe site-ul www.kern-sohn.com/manuals
- I** Trovate altre versioni di lingue online in www.kern-sohn.com/manuals
- SK** Iné jazykové verzie nájdete na stránke www.kern-sohn.com/manuals
- NL** Bijkomende taalversies vindt u online op www.kern-sohn.com/manuals
- SLO** Druge jezikovne različice na voljo na spletni strani www.kern-sohn.com/manuals
- P** Encontram-se online mais versões de línguas em www.kern-sohn.com/manuals
- CZ** Jiné jazykové verze najdete na stránkách www.kern-sohn.com/manuals
- PL** Inne wersje językowe znajdą Państwo na stronie www.kern-sohn.com/manuals
- SE** Övriga språkversioner finns här: www.kern-sohn.com/manuals
- H** A további nyelvi változatok a következő oldalon találhatóak: www.kern-sohn.com/manuals
- HR** Druge jezične verzije su dostupne na stranici: www.kern-sohn.com/manuals
- NO** Andre språkversjoner finnes det på www.kern-sohn.com/manuals



KERN MCB, MPT

Version 3.3 2018-12

Operating instructions chair scales, personal scales

Table of Contents

| | | |
|-----------|---|-----------|
| 1 | Technical Data | 5 |
| 2 | Declaration of conformity | 6 |
| 2.1 | Explanation of the graphic symbols for medical devices | 6 |
| 3 | Basic Information (General) | 9 |
| 3.1 | Specific function | 9 |
| 3.2 | Proper use | 9 |
| 3.3 | Improper Use | 10 |
| 3.4 | Warranty | 11 |
| 3.5 | Monitoring of Test Resources | 11 |
| 4 | Basic Safety Precautions | 11 |
| 4.1 | Pay attention to the instructions in the Operation Manual | 11 |
| 4.2 | Personnel training | 11 |
| 4.3 | Preventing contamination | 12 |
| 4.4 | Appropriate use | 12 |
| 5 | EMC guidance and manufacturer's declaration | 13 |
| 6 | Appliance overview | 17 |
| 7 | Overview of displays | 18 |
| 8 | Keyboard overview | 19 |
| 9 | Transportation & Storage | 20 |
| 9.1 | Testing upon acceptance | 20 |
| 9.2 | Packaging / return transport | 20 |
| 10 | Unpacking, Setup and Commissioning | 21 |
| 10.1 | Place of installation / place of operation | 21 |
| 10.2 | Unpacking | 21 |
| 10.3 | Scope of delivery chair scales | 22 |
| 10.4 | Installing the chair scales | 22 |
| 10.4.1 | Levelling | 23 |
| 10.5 | Scope of delivery, personal scales | 24 |
| 10.6 | Installing the personal scales | 24 |
| 10.7 | Assemble the wall bracket | 24 |
| 10.8 | Attaching an optional stand (only MPT) | 25 |
| 10.9 | Battery operation | 25 |
| 10.10 | Operation using a rechargeable battery (optional) | 27 |
| 10.10.1 | Battery operation | 27 |
| 10.10.2 | Rechargeable battery operation (optional) | 29 |
| 10.11 | Connecting the power supply | 32 |
| 10.12 | Initial Commissioning | 32 |
| 11 | Menu overview | 33 |
| 12 | Operation | 34 |
| 12.1 | Weighing | 34 |
| 12.2 | Taring | 35 |

| | | |
|-------------|--|-----------|
| 12.3 | Hold function (Standstill function) | 35 |
| 12.4 | Calculation of the Body Mass Index | 36 |
| 12.4.1 | Classification of BMI values | 37 |
| 12.5 | PRE-TARE function | 37 |
| 12.5.1 | PRE-TARE function with 5 memories | 38 |
| 12.6 | Print function | 40 |
| 12.6.1 | Interface parameters for RS232 (only MPT) | 41 |
| 13 | Service, maintenance, disposal | 41 |
| 13.1 | Cleaning | 41 |
| 13.2 | Cleaning / disinfecting | 41 |
| 13.3 | Sterilisation | 41 |
| 13.4 | Service, maintenance | 42 |
| 13.5 | Disposal | 42 |
| 14 | Error messages | 42 |
| 15 | Instant help | 43 |
| 16 | Verification | 44 |
| 16.1 | Adjustment | 44 |
| 16.2 | Adjustment controls and seals | 46 |
| 16.3 | Checking the balance verification settings | 47 |
| 16.3.1 | Menu overview in service mode (adjustment switch in adjustment position) | 47 |
| 16.4 | Navigation in the menu | 48 |
| 16.4.1 | Exit menu and save | 48 |
| 16.5 | Verification validity period (current status in G) | 51 |

1 Technical Data

| KERN (Type) | MCB 300K100NM | MPT 300K100NM |
|--|---|---|
| Model | MCB 300K100M | MPT 300K100M |
| Readability (d) | 100 g | |
| Weighing range (max) | 300 kg | |
| Minimum weight (min) | 2 kg | |
| Verification value (e) | 100g | |
| Verification class | III | |
| Recommended adjustment weight, (Class) | 300 kg (M1) | |
| Weighing Units | kg | |
| Stabilization time (typical) | 2-3 sec. | |
| Warm-up time | 10 min | |
| Electric Supply | Supply voltage: 100 V – 240 V AC 50/60 Hz | |
| | Mains adapter: 15 V / 300 mA (EN60601-1) | |
| | Battery operation: 6 x 1,5 V size AA | |
| | Service life 50 h | |
| Auto Off | After 3 min without load change (adjustable) | |
| Operating temperature | + 5°C ... + 35°C | |
| Storage temperature | - 20°C ... + 60°C | |
| Humidity of air | max. 80 % (not condensing) | |
| Dimensions (B x D x H) mm | 647 x 860 x 910 | 340 x 450 x 90 |
| Dimensions display unit (B x D x H) mm | 210 x 110 x 50 | |
| Dimensions seating surface / Weighing platform | 465 x 530 x 410 | 340 x 450 x 90 |
| Weight kg (net) | 21.4 | 8,5 |
| Calibrated in accordance with 2014/31/EU | grade III | |
| Medical product in accordance with 93/42/EEC | Category I with measuring function | |
| Rechargeable battery operation (optional) | Loading time: 14 h; operating time: 50 h; 7.2 V / 2000 mA | Loading time: 14 h; operating time: 50 h; 7.2 V / 2000 mA |

2 Declaration of conformity

To view the current EC/EU Declaration of Conformity go to:

www.kern-sohn.com/ce

i The scope of delivery for calibrated weighing balances (= conformity-rated weighing balances) includes a Declaration of Conformity.

Solely these weighing balances are classified as medical devices.

2.1 Explanation of the graphic symbols for medical devices

All medical scales marked in this way meet the requirements of the following directives:

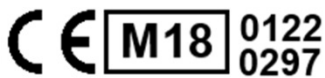

1. 2014/31/EU: Directive on non-automatic weighing instruments
2. 93/42/EC: Directive concerning medical devices



Scales marked in this way underwent the conformity assessment procedure according to Directive 2014/31/EU for scales belonging to 3rd accuracy class.

SN WOC 17000100

Designation of the serial number of every device, applied at the device and on the packaging

Number here as example



Identification of the manufacturing date of the medical product.

Year and month here as example



“Please note the accompanying documents“
or “Observe operating instructions”



Identification of manufacturer of medical product including
address

Kern & Sohn GmbH
D-72336 Balingen,
Germany
www.kern-sohn.com



Please note operating instructions



Please note operating instructions



“Electro-medical appliance“
with attachment for type B

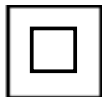

Device protection category II



Dispose of old appliances separately from your household
waste !!!

Instead, take them to communal collection points.

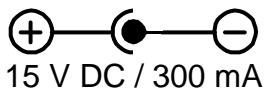

Display of supply voltage for scales with polarity display
(Polarity and values serving as an example)



Do not use the chair scales to transport people and objects!
Do not stand on the footrests when you get on or off the chair scales!

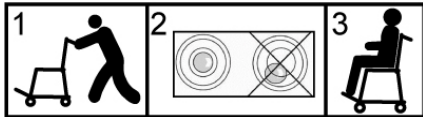

After taking chair scales to patient, ensure scales are level before starting the weighing process.



Power connection



Seal KERN SEAL



Supply voltage direct current



Information

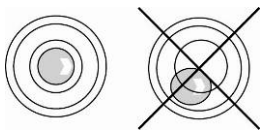

Level balance before use

3 Basic Information (General)



Weighing instruments have to be verified for the purposes stated below in accordance with Directive 2014/31/EU. Article 1, paragraph 4. “Determination of mass in the practice of medicine that is, weighing patients for reasons of medical supervision during medical surveillance, examination and treatment.”

3.1 Specific function

- Indication**
- Determining the body weight in the medical practice area.
 - To be used as “non-automatic weighing instruments“, that is, a person will step or sit down carefully onto the centre of the seating surface or weighing platform. The weighing value can be read after a steady display value has been achieved.
- Contra-indication**
- No contraindication known.

3.2 Proper use

These scales serve as a means of determining the weight of people in a seated or standing position, in medical treatment rooms. The scales are suitable for recognizing, preventing and controlling illnesses.



Scales fitted with a serial interface may only be connected to appliances in compliance with Directive EN60601-1.

The person to be weighed should be seated in the centre of the seating surface or step onto the weighing platform and sit or stand still.



As soon as a stable weighing value is reached the weighing value can be read. The scales are designed for long-term usage.





Scales may only be used for people who are able to sit or stand still.

The balances should be checked for correct condition prior to each utilisation by a person familiar with proper operation of the balance.

When the scale doesn't connect with the transmission cable, please do not touch the transmission port to prevent ESD interference occurs.

- Do not use the chair scales to transport people and objects!
- Until the weighed person stays on the chair scales, the wheel brakes must **always** be activated.
- The armrests of the chair scales are designed solely for resting arms and not for supporting.
- When going off and on, a trained person should fold the armrests up (raise) and help the weighed person.
- The chair scales should always be placed on flat, smooth surface.

- Do not stand on the footrests when you get on or off the chair scales!

3.3 Improper Use

Do not use these scales for dynamic weighing processes.

Do not leave continuous loads on the seating surface or weighing plate. This may damage the measuring system.

Impacts and overloading exceeding the stated maximum load (max) of the seating surface or the weighing plate, minus a possibly existing tare load, must be strictly avoided. This could cause damage to the balance.

Never operate balance in explosive environment. The serial version is not explosion protected. It should be noted that a flammable mixture of anaesthetics and oxygen or laughing gas may occur.

Do not modify the construction of the scales. This may lead to incorrect weighing results, safety-related faults and destruction of the balances.

The balances may only be used according to the described conditions. Other areas of use must be released by KERN in writing.

3.4 Warranty

Warranty claims shall be voided in case

- Our conditions in the operation manual are ignored
- The appliance is used outside the described uses
- Modification or opening of appliances
- mechanical damage and damage caused by media, liquids,
- Natural wear and tear
- The appliance is improperly set up or incorrectly electrically connected
- The measuring system is overloaded
- Dropping of scales

3.5 Monitoring of Test Resources

In the framework of quality assurance the measuring-related weighing properties of the balances and, if applicable, the testing weight, must be checked regularly. The responsible user must define a suitable interval as well as type and scope of this test. Information is available on KERN's home page (www.kern-sohn.com) with regard to the monitoring of balance test substances and the test weights required for this. In KERN's accredited DKD calibration laboratory test weights and balances may be calibrated (return to the national standard) fast and at moderate cost.

4 Basic Safety Precautions

4.1 Pay attention to the instructions in the Operation Manual



Carefully read this operation manual before setup and commissioning, even if you are already familiar with KERN balances.



4.2 Personnel training

The medical staff must apply and follow the operating instructions for proper use and care of the product.

4.3 Preventing contamination

To prevent cross-contamination (fungal skin infections, ...), clean the seating surface or weighing platform every time.

Recommendation: after a weighing procedure that could potentially result in contamination (e. g. after weighing that involves direct skin contact).

4.4 Appropriate use

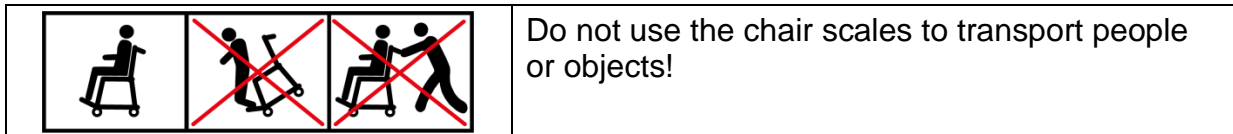

- Always get on and off the chair scales in the presence of a qualified person (see Chapter 4.2)
- Before every use inspect the scales for any signs of damage.
- Maintenance and repeated verification
Chair scales should be maintained and verified at regular intervals (see chapter 16.5)

5 EMC guidance and manufacturer's declaration

| Guidance and manufacturer's declaration-electromagnetic emissions | | |
|---|-------------------|---|
| <p>The MCB-NM, MPT-NM is intended for use in the electromagnetic environment specified below.</p> <p>The customer or the user of the MCB-NM, MPT-NM should assure that it is used in such an environment.</p> | | |
| Emission test | Compliance | Electromagnetic environment-guidance |
| RF emissions CISPR 11 | Group 1 | The MCB-NM, MPT-NM uses RF energy only for its internal function. Therefore, its RF emissions are very low and are not likely to cause any interference in nearby electronic equipment. |
| RF emissions CISPR 11 | Class B | The MCB-NM, MPT-NM is suitable for use in all establishments, including domestic establishments and those directly connected to the public low-voltage power supply network that supplies buildings used for domestic purposes. |
| Harmonic emissions IEC 61000-3-2 | Class A | |
| Voltage fluctuations /flicker emissions IEC 61000-3-3 | Compliance | |

Guidance and manufacturer's declaration-electromagnetic immunity

The MCB-NM, MPT-NM is intended for use in the electromagnetic environment specified below. The customer or the user of the MCB-NM, MPT-NM should assure that it is used in such an environment.

| Immunity test | IEC 60601 test level | Compliance level | Electromagnetic environment-guidance |
|---|---|---|--|
| Electrostatic discharge(ESD) IEC 61000-4-2 | ± 6 kV contact ± 8 kV air | ± 6 kV contact ± 8 kV air | Floors should be wood, concrete or ceramic tile. If floors are covered with synthetic material, the relative humidity should be at least 30% |
| Electrical fast transient/burst IEC 61000-4-4 | ± 2kV for power supply lines + 1kV for input/output lines | ± 2kV for power supply lines Not applicable | Mains power quality should be that of a typical commercial or hospital environment. |
| Surge IEC 61000-4-5 | ± 1kV line(s) to line(s) ± 2kV line(s) to earth | ± 1kV differential mode Not applicable | Mains power quality should be that of a typical commercial or hospital environment. |
| Voltage Dips, short interruptions and voltage variations on power supply input lines IEC 61000-4-11 | <5% UT(>95% dip in UT) for 0,5 cycle 40% UT(60% dip in UT) for 5 cycles 70% UT(30% dip in UT) for 25 cycles <5% UT(>95% dip in UT) for 5 s | <5% UT(>95% dip in UT) for 0,5 cycle 40% UT(60% dip in UT) for 5 cycles 70% UT(30% dip in UT) for 25 cycles <5% UT(>95% dip in UT) for 5 s | Mains power quality should be that of a typical commercial or hospital environment. If the user of the MCB-NM, MPT-NM requires continued operation during power mains interruptions, it is recommended that the MCB-NM, MPT-NM be powered from an uninterruptible power supply or a battery. |
| Power frequency(50/60 Hz) magnetic field IEC 61000-4-8 | 3 A/m | 3 A/m | MCB-NM, MPT-NM power frequency magnetic fields should be at levels characteristic of a typical location in a typical commercial or hospital environment. |

NOTE UT is the a.c. mains voltage prior to application of the test level.

Guidance and manufacturer's declaration-electromagnetic immunity

The MCB-NM, MPT-NM is intended for use in the electromagnetic environment specified below. The customer or the user of the MCB-NM, MPT-NM should assure that is used in such and environment.

| Immunity test | IEC 60601 test level | Compliance level | Electromagnetic environment-guidance |
|-------------------------------|-----------------------------|------------------|--|
| Conducted RF IEC 61000-4-6 | 3 Vrms 150 KHz to 80 MHz | 3 Vrms | <p>Portable and mobile RF communications equipment should be used no closer to any part of the MCB-NM, MPT-NM including cables, than the recommended separation distance calculated from the equation applicable to the frequency of the transmitter.</p> <p>Recommended separation distance: $d = 1,2 \sqrt{P}$ $d = 1,2 \sqrt{P}$ 80MHz to 800 MHz $d = 2,3 \sqrt{P}$ 800MHz to 2,5 GHz</p> <p>Where P is the maximum output power rating of the transmitter in watts (W) according to the transmitter manufacturer and d is the recommended separation distance in metres (m).</p> |
| Radiated RF IEC 61000-4-3 | 3 V/m 80MHz to 2,5 GHz | 3 V/m | <p>Field strengths from fixed RF transmitters, as determined by an electromagnetic site survey^a, should be less than the compliance level in each frequency range^b.</p> <p>Interference may occur in the vicinity of equipment marked with the following symbol:</p>  |

NOTE1 At 80 MHz and 800 MHz, the higher frequency range applies.

NOTE2 These guidelines may not apply in all situations. Electromagnetic propagation is affected by absorption and reflection from structures, objects and people.

a Field strengths from fixed transmitters, such as base stations for radio (cellular/cordless) telephones and land mobile radios, amateur radio, AM and FM radio broadcast and TV broadcast cannot be predicted theoretically with accuracy. To assess the electromagnetic environment due to fixed RF transmitters, an electromagnetic site survey should be considered. If the measured field strength in the location in which the MCB-NM, MPT-NM is used exceeds the applicable RF compliance level above, the MCB-NM, MPT-NM should be observed to verify normal operation. If abnormal performance is observed, additional measures may be necessary, such as re-orienting or relocating the MCB-NM, MPT-NM

b Over the frequency range 150 kHz to 80 MHz, field strengths should be less than 3 V/m.

**Recommended separation distance between
portable and mobile RF communications equipment and the MCB-NM, MPT-NM**

The MCB-NM, MPT-NM is intended for use in an electromagnetic environment in which radiated RF disturbances are controlled. The customer or the user of the MCB-NM, MPT-NM can help prevent electromagnetic interference by maintaining a minimum distance between portable and mobile RF communications equipment (transmitters) and the MCB-NM, MPT-NM as recommended below, according to the maximum output power of the communications equipment.

| Rated maximum output power of transmitter W | Separation distance according to frequency of transmitter m | | |
|--|---|--|---|
| | 150 kHz to 80 MHz $d = 1,2\sqrt{P}$ | 80 MHz to 800 MHz $d = 1,2\sqrt{P}$ | 800 MHz to 2,5 GHz $d = 2,3\sqrt{P}$ |
| 0,01 | 0,12 | 0,12 | 0,23 |
| 0,1 | 0,38 | 0,38 | 0,73 |
| 1 | 1,2 | 1,2 | 2,3 |
| 10 | 3,8 | 3,8 | 7,3 |
| 100 | 12 | 12 | 23 |

For transmitters rated at a maximum output power not listed above, the recommended separation distance d in metres (m) can be estimated using the equation applicable to the frequency of the transmitter, where p is the maximum output power rating of the transmitter in watts (W) according to the transmitter manufacturer.

NOTE1 At 80 MHz and 800 MHz, the separation distance for the higher frequency range applies.

NOTE2 These guidelines may not apply in all situations. Electromagnetic propagation is affected by absorption and reflection from structures, objects and people.

6 Appliance overview

Chair scales MCB

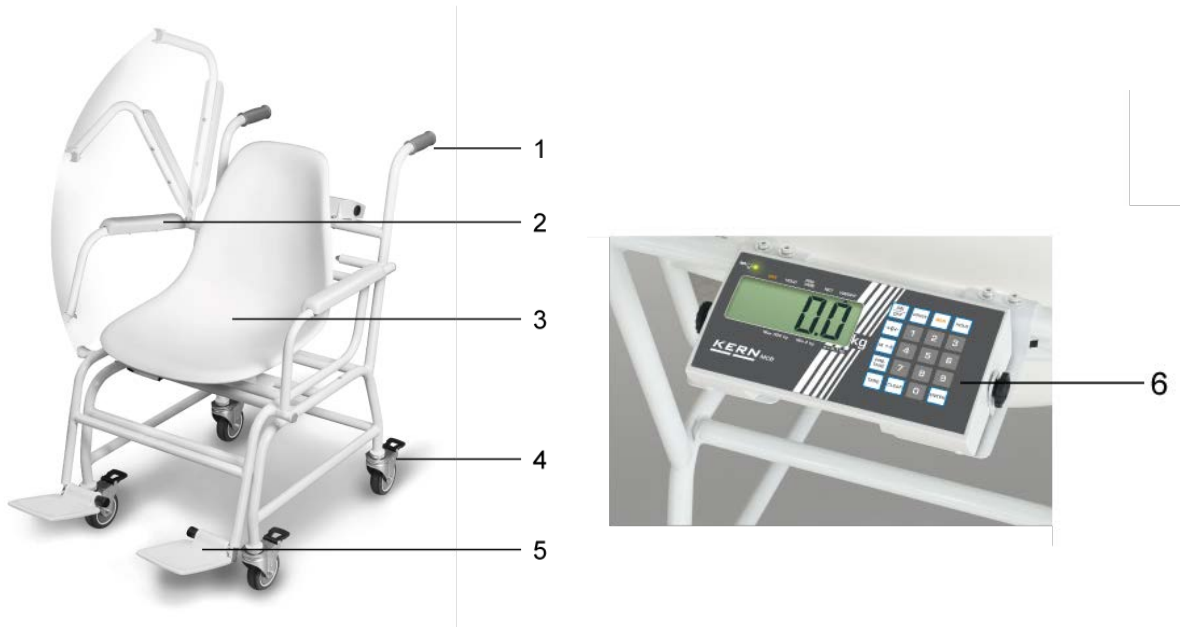

1. Gripping handles
2. Folding arm rests
3. Seating surface
4. Locking castors
5. Foot rests
6. Display unit at rear

Personal scales MPT



1. Weighing plate
2. Bubble level
3. Height adjustable rubber feet
4. Gripping handle
5. Display unit

Chair scales MCB

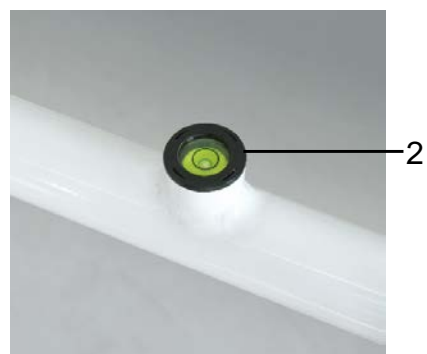

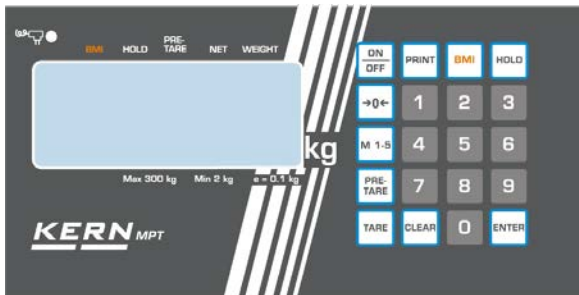

7 Overview of displays













Typ MPT 300K100NM



Typ MCB 300K100NM

| Display | Designation | Description |
|---|--------------------------|--|
| ○ | Stability display | Scales are in a steady state |
| →0← | Zeroing display | Should the balance not display exactly zero despite empty scale pan, press the  button. Your balance will be set to zero after a short standby time. |
|  ○ | Power supply connected | Illuminates in the event of power supply via mains adaptor |
| BMI | BMI function active | Calculated BMI value |
| ▲ | HOLD function active | Hold/Save function active |
| HOLD | HOLD function active | Hold/Save function active |
| ▲ | PRE-Tare function active | Preset tare value is enabled |
| PRE-TARE | PRE-Tare function active | Preset tare value is enabled |
| ▲ | Net weight display | Net weight will be displayed |
| NET | Net weight display | Net weight will be displayed |
| ▲ | Weight value display | Current weight value will be displayed |
| WEIGHT | Weight value display | Current weight value will be displayed |

8 Keyboard overview

| Button | Designation | Function |
|---|------------------|--|
|  | ON/OFF-switch | Turn on/off |
|  | PRINT button | Data transfer via interface |
|  | BMI button | Calculation of the Body Mass Index |
|  | HOLD button | Hold function/Calculation of a stable weight value |
|  | Zero setting key | Balance will be reset to 0.0 kg. Possible up to max. 2% of maximum load for verified scales or 2 % or 100% of maximum load for all other scales (selectable via menu) |
|  | Save button | Retrieve memory 1-5 |
|  | Pretare button | Call tare function with defined values |
|  | Tare button | Tare balance |
|  | CLEAR button | This deletes manual number entry |
|  | ENTER-key | Import of numeric entry |
|  | Numeric keys | Numeric entry |

9 Transportation & Storage

9.1 Testing upon acceptance

When receiving the appliance, please check packaging immediately, and the appliance itself when unpacking for possible visible damage.

9.2 Packaging / return transport



- ⇒ Keep all parts of the original packaging for a possibly required return.
- ⇒ Only use original packaging for returning.
- ⇒ Prior to dispatch disconnect all cables and remove loose/mobile parts.
- ⇒ Reattach possibly supplied transport securing devices.
- ⇒ Secure all parts such as the weighing platform, power unit etc. against shifting and damage.

10 Unpacking, Setup and Commissioning

10.1 Place of installation / place of operation

The balances are designed in a way that reliable weighing results are achieved in common conditions of use. You will work accurately and fast, if you select the right location for your balance.

On the installation site observe the following:

- Place scales on a stable, even surface
- Avoid extreme heat as well as temperature fluctuation caused by installing next to a radiator or in the direct sunlight;
- Protect the balance against direct draughts due to open windows and doors;
- Avoid jarring during weighing;
- Protect the balance against high humidity, vapors and dust;
- Do not expose the device to extreme dampness for longer periods of time. Non-permitted condensation (condensation of air humidity on the appliance) may occur if a cold appliance is taken to a considerably warmer environment. In this case, acclimatize the disconnected appliance for ca. 2 hours at room temperature.
- Avoid static charge of the balance and of the person to be weighed.
- Avoid contact with water.

Major display deviations (incorrect weighing results) may be experienced should electromagnetic fields (e.g. due to mobile phones or radio equipment), static electricity accumulations or instable power supply occur. In that case, the location must be changed.

10.2 Unpacking

Remove the individual components of the balance or the complete balance from the packaging with care and install at the intended location. When using the power pack, ensure that the power cable does not produce a risk of stumbling.

10.3 Scope of delivery chair scales

- Balance
- Operating instructions
- Mains adapter

10.4 Installing the chair scales



In delivery state the balance is adjusted in a manner that when placed on an even surface the air bubble of the water balance is in the prescribed circle.



- ⇒ To check place scales on an even surface.
- ⇒ Check if the air bubble of the level is within the prescribed circle.

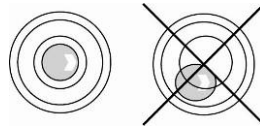

- ⇒ If the air bubble in the level is **not** within the prescribed circle, the wheel height has to be adjusted, see chap. 9.4.1.
- ⇒ Check levelling regularly.

10.4.1 Levelling



- The wheel height has to be adjusted for levelling.
- Levelling is restricted to specialist staff possessing well acquainted with the workings of weighing scales.

- ⇒ Place scales on an even surface.
- ⇒ Arrest the brake



- ⇒ Turn the wheel (1) clockwise until the air bubble of the water balance is in the prescribed circle

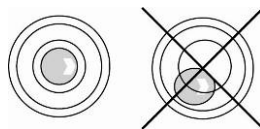
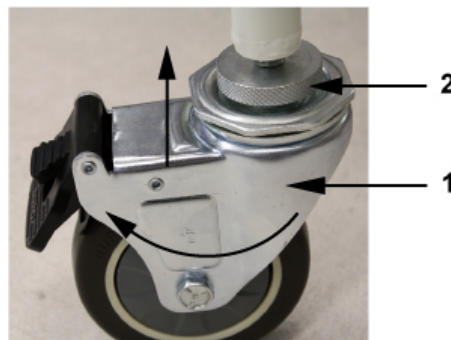

Screw counternut (2) upwards till to the stop and it with a suitable tool (e.g. pliers).

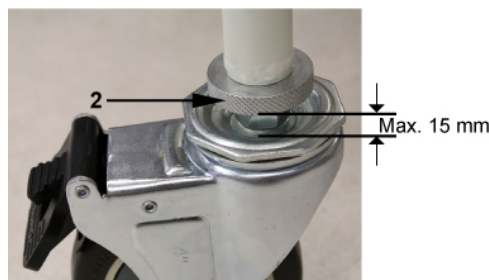

Gap width must not exceed 15 mm!

10.5 Scope of delivery, personal scales

- Balance
- Operating instructions
- Mains adapter
- Wall bracket
- 4 rubber feet

10.6 Installing the personal scales

⇒ Place scales on an even surface

⇒ Level balance with foot screws until the air bubble of the water balance is in the prescribed circle.

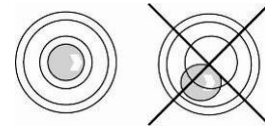
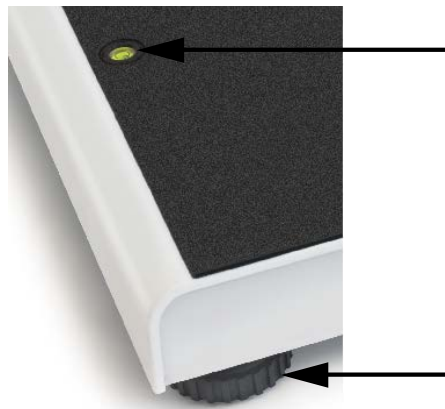

10.7 Assemble the wall bracket

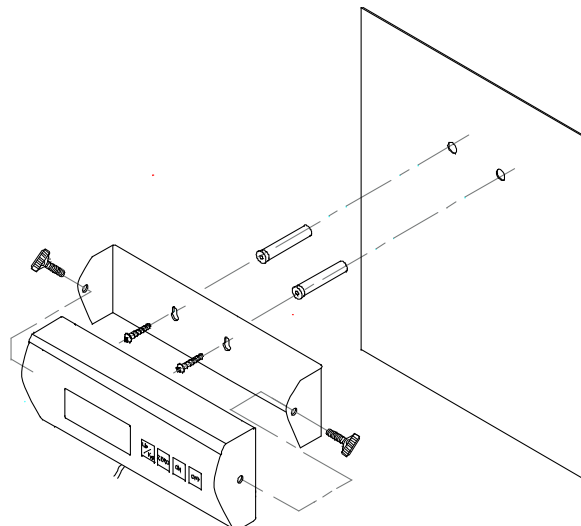

10.8 Attaching an optional stand (only MPT)



- ⇒ Secure circular plate with screws on the aluminium section
- ⇒ Secure wall fixing device with screws at the top on the aluminium section
- ⇒ Remove the two lateral rubber plugs from the display unit.
- ⇒ Secure the display unit with the two rotary knobs to the fixing device.
- ⇒ Position display unit with the rotary knobs.
- ⇒ Secure cable with cable clips

10.9 Battery operation

On models where the back of the display unit is not directly accessible, remove the two black rotary knobs from both sides of the display unit in order to open the battery compartment and remove the display unit from the holder.



- ⇒ Remove the battery cover [2] from the underside of the scales



- ⇒ Take out the battery holder



- ⇒ Insert 6 batteries (1.5 V AA)

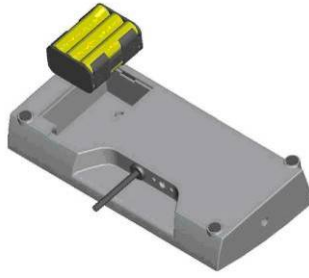

⇒ Ensure that the batteries are inserted in the correct direction



⇒ Insert the battery holder with the inserted batteries in the display unit

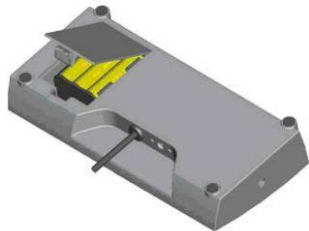

⇒ Close the battery cover



If the batteries are run down, "**LO**" appears in the display.

To turn off scales, press the



button and immediately change the batteries.

If the balance is not used for a longer time, take out the batteries and store them separately. Leaking battery liquid could damage the balance.

10.10 Operation using a rechargeable battery (optional)

In devices with an optional rechargeable battery operation:

Connection **CN 3** for
rechargeable battery

Connection **CN 4** for
batteries (AA x 6)

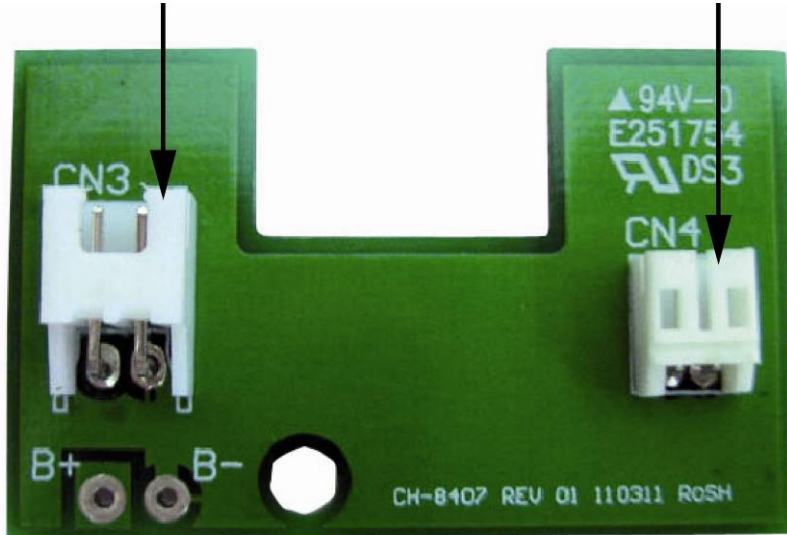

10.10.1 Battery operation

On models where the back of the display unit is not directly accessible, remove the two black rotary knobs from both sides of the display unit in order to open the battery compartment and remove the display unit from the holder.

⇒ Lift-off the battery cover on the lower side of the balance



⇒ Carefully take out the battery holder (1)



⇒ Insert 6 batteries (AA).
Ensure that the batteries are inserted in the correct direction



⇒ Insert battery holder with the inserted batteries into the display unit
Ensure that the cables are not squeezed



⇒ Close the battery cover

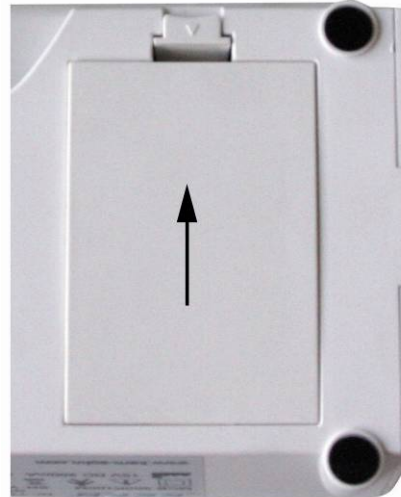

If the batteries are run down, "LO" appears in the display. To turn off, press the  button and immediately change the batteries. If the balance is not used for a longer time, take out the batteries and store them separately. Leaking battery liquid could damage the balance.

10.10.2 Rechargeable battery operation (optional)

When an optional rechargeable battery is used, proceed as follows:

On models where the back of the display unit is not directly accessible, remove the two black rotary knobs from both sides of the display unit in order to open the battery compartment and remove the display unit from the holder.

⇒ Lift-off the battery cover on the lower side of the balance



⇒ Carefully take out the battery holder (1)

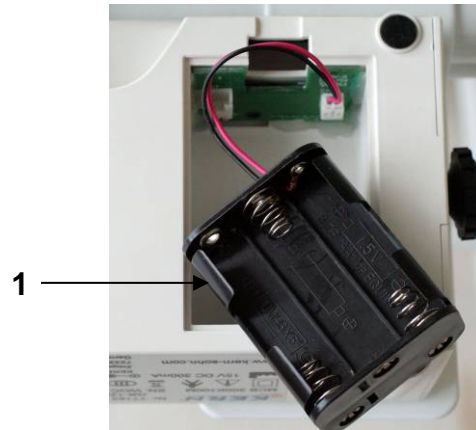

⇒ Carefully pull-out plug (2) from the connection **CN 4** (3)

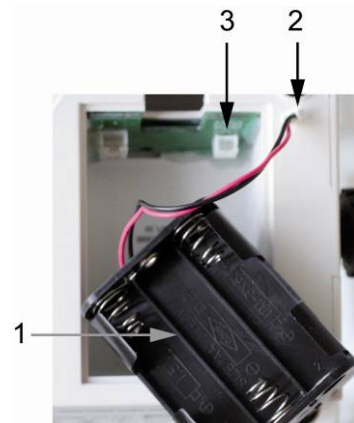

⇒ Carefully insert the rechargeable battery block and insert plug into connection **CN 3**
Ensure that the cables are not squeezed



⇒ Close the battery cover

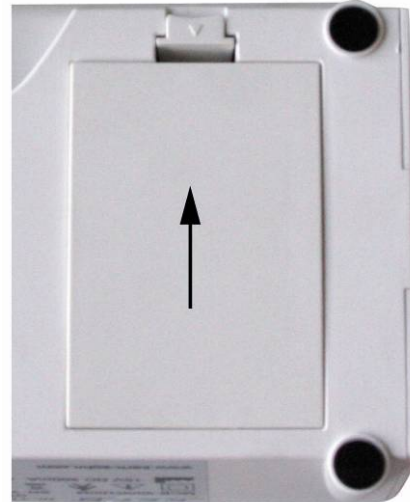

If the rechargeable battery is exhausted, „LO“ is displayed. The rechargeable battery is loaded via the provided plug-in power supply unit (loading time 14 h for a complete loading). If the balance is not used for a longer time, take out the rechargeable battery and store it separately. Leaking liquid could damage the balance.

10.11 Connecting the power supply

Power is supplied via the external mains adapter which also serves to isolate the scales from the mains.

The stated voltage value must be the same as the local voltage. Only approved genuine KERN power supply units may be used in compliance with Directive EN 60601-1.

The small sticker attached to the side of the display unit indicates the power port:

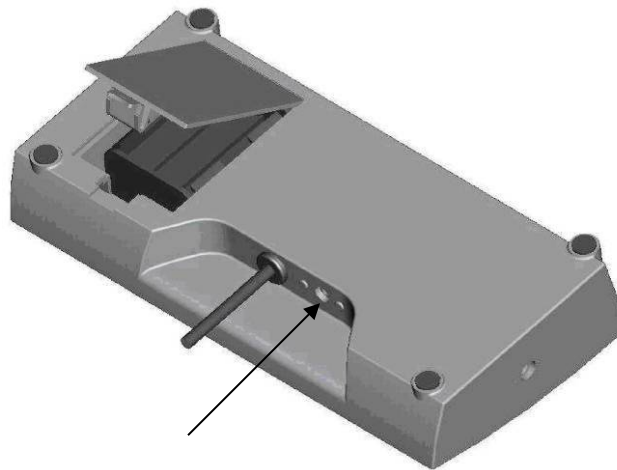

10.12 Initial Commissioning

In order to obtain exact results with the electronic balances, your balance must have reached the operating temperature (see warming up time chap. 1). During this warming up time the balances must be connected to the power supply (mains, accumulator or battery) and be switched on.

The accuracy of the balance depends on the local acceleration of gravity.

The value of gravity acceleration is shown on the type plate.

11 Menu overview



⇒ Start balance by pressing 

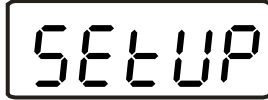

⇒ Press  for 3 sec., "SETUP" will be displayed.

⇒ Select parameter by using  (→) and  (↓), as described.

⇒ Confirm the selected parameter by pressing  (→).

| Function | Settings | Description |
|---|---|--------------------------------|
| SEtUP | | |
| A. oFF Automatic cutout Auto Off | 180 s | Automatic shutdown after 3 min |
| | 240 s | Automatic shutdown after 4 min |
| | 300 s | Automatic shutdown after 5 min |
| | oFF | Automatic shutdown off |
| | 120 s | Automatic shutdown after 2 min |
| burr Akustisches Signal | on | Acoustic signal on |
| | oFF | Acoustic signal off |
| End | Exit menu by pressing  | |

12 Operation

After taking chair scales to patient, ensure scales are level before starting the weighing process. See diagram below

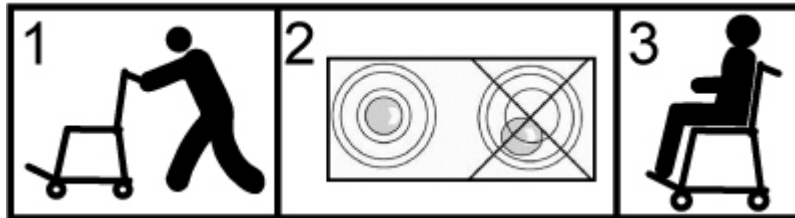

Always get on and off the chair scales in the presence of a qualified person (see Chapter 4.2)

12.1 Weighing

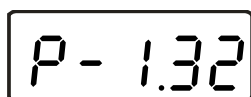

- ⇒ Start balance by pressing . The balance carry out a segment test, then the program version is displayed. The scales are ready for operation as soon as the weight display for “0.0kg” has appeared.



- The  button can be used to set the balance to zero at any time.

Chair scales

- ⇒ Seat the person in the centre of the scales.
- ⇒ Fold down (lower) the footrests and armrests. Support both feet of the weighed person on the footrests.
- ⇒ Place the forearms of the weighed person on the armrests.
- ⇒ Wait until stabilisation indicator is displayed , and then read the weighing result.
- ⇒ After weighing is finished, fold up (raise) the footrests and armrests again.

Personal scales

- ⇒ Have person stand in the centre of the scales
- ⇒ Wait for the rest position display , then read the weighing result.



- If a person is heavier than the maximum weighing range, “Err” (overload) will appear on the display screen.

12.2 Taring

The tare weight of any preloads can be deducted by pressing a button so that the actual weight of the person is displayed in subsequent weighing.



⇒ Place an object (such as a towel or support) on the seating surface or weighing platform.



⇒ Press , the zero display appears.



⇒ Have person sit or stand in the centre of the scales.
Wait until the standstill display  appears, then read the weighing result.





- The balance is able to only store one taring value.
- When the balance is unloaded the saved taring value is displayed with negative sign.
- To delete the stored tare value, release scales and press .

12.3 Hold function (Standstill function)

The balance has an integrated standstill function (mean value calculation). This allows correct weighing determination of a person although the latter is not keeping still on the scales.



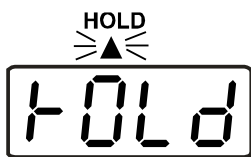

⇒ Start balance by pressing 
Wait for the rest position display .



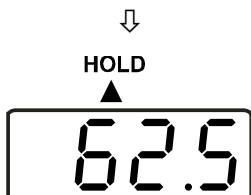

⇒ Have person sit or stand in the centre of the seating surface or weighing platform.

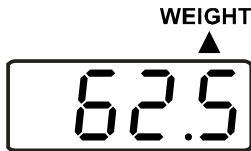

⇒ Press 
A triangle  starts to flash in the display, during this time the balance will record several measuring values and will then display the calculated average value.



⇒ By pressing the  button several times, the balance returns to the normal weighing mode.



⇒ Press the  button once more to repeat this function as often as required.



There is no average value calculation in the event of too much movement.

12.4 Calculation of the Body Mass Index



⇒ Start balance by pressing  .
Wait for the rest position display  .



⇒ Have person sit or stand in the centre of the seating surface or weighing platform.
Wait for the rest position display  .

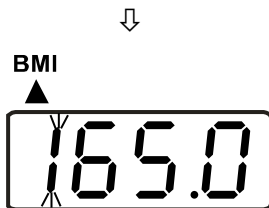

⇒ Press  .
The first decimal place of the most recently entered body height is flashing.



It should be noted that a reliable calculation of the BMI is only possible with a body height of between 100 cm and 250 cm and a weight >10kg.



⇒ Go to the numeric keypad and enter a different value.

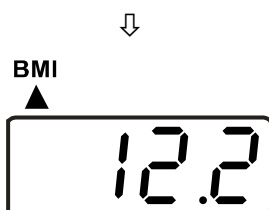

⇒ Confirm with  key
The BMI of the person will be shown.

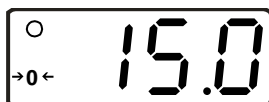

⇒ Press again  and the scales will return to weighing mode.

12.4.1 Classification of BMI values



Weight classification for adults over 18 years of age using the BMI in accordance with WHO, 2000 EK IV and WHO 2004.

| Categorie | BMI (kg/m ²) | Risk of diseases associated with overweight |
|--------------------|---------------------------|---|
| Underweight | < 18,5 | low |
| Normal weight | 18.5 – 24.9 | Average |
| Overweight | ≥ 25.0 | A bit high High High Very high |
| Pre-adipose | 25.0 – 29.9 | |
| Adipose degree I | 30.0 – 34.9 | |
| Adipose degree II | 35.0 – 39.9 | |
| Adipose degree III | ≥ 40 | |

12.5 PRE-TARE function

If the tare weight is known (rubber mat, clothing.....) . you may enter the value manually.



Start balance by pressing .
Wait for the rest position display .

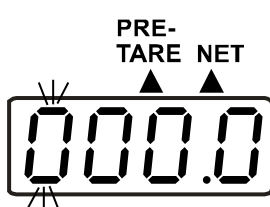

⇒ Press  briefly.
A flashing display appears.
A small arrow will be shown on the display under “PRE-TARE” and under “NET” as long as the PRE-Tare function is enabled.
The most recently applied value or “000.0” will appear.

⇒ Go to the numeric keypad and enter a new value.

⇒ Confirm value with .

The entered value appears on the display with a minus in front.

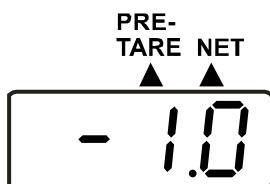

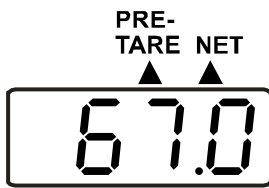

⇒ Have the person sit or stand on the scales
The weight value reduced by the previously entered tare value will be shown.



⇒ To return to normal weighing mode, again press the



12.5.1 PRE-TARE function with 5 memories

This gives the option of storing 5 different tare values that can be retrieved when required.

Saving PPE-TARE values



Weighing platform is unloaded and indicates "0.0 kg".



⇒ Place the weight to be saved on the weighing platform and wait until the weight display is steady.

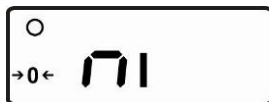

⇒ Keep pressing the  button until "ni" (M) appears.

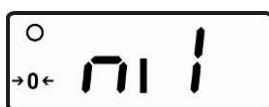

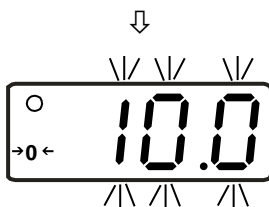

⇒ Briefly press the **numeric key (1..5)** that you wish to use for saving the value. The weight value displayed beforehand will be flashing for approx. 3 seconds.





- ⇒ Once flashing has finished, press the same **numeric key** as above.
This will save the weighing value to the memory (audio sound).
The weighing value will be indicated.
On removal of the weight, "0.0kg" will appear.

Press  to return to weighing mode, without saving.

Retrieving PPE-TARE values from the memory



Weighing platform is unloaded and indicates "0.0 kg".



- ⇒ Press and hold the  button until "ni" appears and starts flashing on the display.

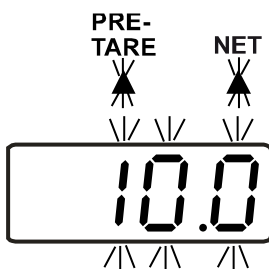

- ⇒ Briefly press the **numeric key (1..5)** under which number the Pre-Tare value was saved.
The saved weight value will be flashing.
In addition there will be a flashing triangle ▲ under "PRE-TARE" and "NET".

- ⇒ Import value with .

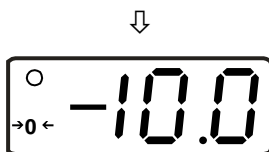

Value will be shown with a negative sign.





- ⇒ Have the person sit or stand on the scales.
Only the person's weight will be indicated.



- ⇒ To return to weighing mode, unload the scales and press PRETARE.

Printout from PRE-TARE memory

- ⇒ Press  and hold until “ni” (M) appears on the display.
- ⇒ To issue the values saved to the 5 memories, briefly press the  button.

Example:

M1 0.0 kg
M2 7.0 kg
M3 10.0 kg
M4 30.0 kg
M5 50.0 kg

12.6 Print function

This action requires the RS232 interface cable available as an accessory which has to be connected via the round plug to the rear end of the terminal.

(Loosen the two screws from the side, take off the display unit, insert the cable and screw the display unit back on.)



In a medical context only auxiliary equipment in compliance with Directive EN 60601-1 may be connected to the interface.

Pressing the **PRINT** – key whilst the scales are in weighing mode will trigger a printout of the determined data via the interface, as described in the following. This is a standard output that cannot be modified.

Example:

| | | |
|---|----------|-----------------|
| G | 88.8 kg | Gross weight |
| T | 2.0 kg | Taring weight |
| N | 86.8 kg | Net weight |
| | 180.0 cm | Size of patient |
| | 24.4 BMI | BMI value |

12.6.1 Interface parameters for RS232 (only MPT)

The interface parameters of the scales have to be set at the connected appliance. It is not possible to change the parameters inside the scales.

| | |
|--------------|------------------|
| BAUD RATE | 9600 bps |
| PARITY CHECK | none |
| DATA LENGTH | 8 Bit |
| STOP BIT | 1 Bit |
| HANDSHAKE | None or Xon/Xoff |
| DATA CODE | ASCII |

13 Service, maintenance, disposal

13.1 Cleaning

Disconnect the unit from the mains power supply prior to cleaning.

13.2 Cleaning / disinfecting

Clean weighing platform (such as seat) as well as casing with household detergents or commercially available disinfectants, e.g. 70% isopropanol. We recommend a disinfectant suitable for wiping disinfection. Please follow manufacturer's instructions.

Do not use abrasive or aggressive cleaners such as spirits or alcohol or similar as they might damage the high-quality surface.

To prevent cross-contamination (fungal skin infection) please observe the following time intervals for disinfection:

- Weighing plate before and after any measurement with direct skin contact
- When required:
 - Display
 - Touch-sensitive keyboard



Do not spray disinfectants onto appliance.

Make sure that disinfectant does not penetrate the interior of the balance.

Remove dirt immediately.

13.3 Sterilisation

Sterilisation of the appliance not allowed.

13.4 Service, maintenance

The appliance may only be opened by trained service technicians who are authorized by KERN.

We recommend regular verification of conformity with technical safety requirements (STK).

Disconnect the scales before opening.

13.5 Disposal

Disposal of packaging and appliance must be carried out by operator according to valid national or regional law of the location where the appliance is used.

14 Error messages

Display

Description

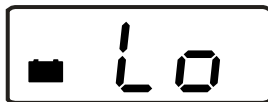

Battery low
Please replace the batteries or connect scales to the power supply, using an adaptor.



Underload
Weight on weighing platform is too low.
Please increase weight.
If the error message remains inform manufacturer.



Overload
Weight on weighing platform is too heavy.



Program error
Please contact your supplier.

15 Instant help

In case of a fault in the program sequence, the balance should be shortly switched off. The weighing process must then be restarted from the beginning.

Failure:

Possible cause:

The displayed weight does not glow.

- The balance is not switched on.
- The mains supply connection has been interrupted (mains cable not plugged in/faulty).
- Check fuse of adapter / glowing green LED next to fuse
- Power supply interrupted.
- Batteries are inserted incorrectly or empty
- No batteries inserted.

The displayed weight is permanently changing

- Draught/air movement
- Table/floor vibrations
- The seat surface/weighing plate is in contact with foreign bodies or is not correctly positioned.
- Electromagnetic fields / static charging (choose different location/switch off interfering device if possible)

The weighing result is obviously incorrect

- The display of the balance is not at zero.
- Adjustment is no longer correct.
- Great fluctuations in temperature.
- The balance is on an uneven surface.
- Electromagnetic fields / static charging (choose different location/switch off interfering device if possible)

Should other error messages occur, switch balance off and then on again. If the error message remains inform manufacturer.

16 Verification

Verified scales bear a verification mark or one or more seals affixed by the Bureau of Standards or the manufacturer on or inside the housing which will self-destroy on removal. This makes it impossible to verify scales without damaging the seals.

16.1 Adjustment

Observe stable environmental conditions. A warming up time (see chapter 1) is required for stabilization.



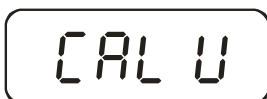

In calibrated balances the adjustment function is switch locked. In order to carry out adjustments, the switch must be turned to adjustment position (centre position). (see chapter 15.2).

Display



Operation

⇒ Start balance by pressing 

⇒ Press  for approx. 3 sec, in the display appears „SETUP“, followed by „UNIT“

⇒ Press  repeatedly until „CAL iB“ appears

⇒ Press , „CAL U“ appears

⇒ Press , the appeared triangle ◀ must be located in the upper left part of the display.

If not, press again .

CAL U

⇒ Press **HOLD** repeatedly until "CAL 0" appears.



CAL 0

30770

⇒ Press **TARE**,
the display will show a numeric value.



CAL 0

⇒ Then press **ENTER**,
"CAL 0" appears.

CAL 5

⇒ Press **HOLD**,
"CAL 5" appears.

↙ ↘
200.0
↖ ↗

⇒ Press **TARE**
Enter the required size of the adjustment weight (See
Section 1, "Technical Data"):



↙ ↘
250.0
↖ ↗

For this select the digit to be changed with **HOLD** and the
numeric value using **TARE**.

↙ ↘
0
↖ ↗

⇒ Acknowledge by **ENTER**.

↙ ↘
82077
↖ ↗

⇒ Place the adjustment weight carefully in the centre of the
weighing plate; a numerical value will appear in the display.

⇒ **ENTER** Press
The adjustment process is started.

250.0

The balance will automatically return to Weighing mode upon
successful completion of the adjustment and will display the
weight of the adjustment weight.

Take away adjustment weight.



For verified scales, turn off the scales and move the
adjustment switch back to verification position.

16.2 Adjustment controls and seals

After a verification the balance is sealed at the indicated positions.



Verification of the balance is invalid without the "seal".

Position of the official seals:

1. Rear



2. Battery compartment



Position of the adjustment switch:

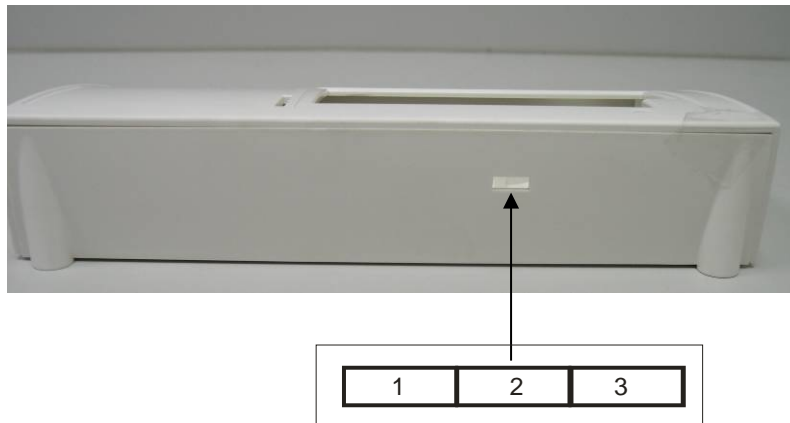

| Position of the adjustment switch | State |
|-----------------------------------|---|
| 1. to the left | Not documented |
| 2. concentric | Adjustment position – adjustment possible |
| 3. to the right | Verification position - Adjustment locked |

16.3 Checking the balance verification settings

For the adjustment function, the balance must be switched over to service mode. To achieve the effect, turn the adjustment switch to adjustment position.





In the service mode all parameters of the balance can be modified. The service parameters may not be modified, as this could damage the balance settings.

16.3.1 Menu overview in service mode (adjustment switch in adjustment position)



This overview is merely for checking the parameters set by the appropriate Bureau of Standards.

Changes may only be made to the parameters for the automatic shut-off function "R.OFF" and the audio signal "bUrr".

16.4 Navigation in the menu

- ⇒ With the balance switched on, keep the  button depressed for approx. 3 sec until "SETUP" is displayed followed by "9rAd".
- ⇒ Press the  button as often as necessary until the required function is displayed.
- ⇒ Press the  button to confirm the selected function. The first parameter will be displayed.
- ⇒ Press the  button to select the required parameter and confirm by pressing the  button.

16.4.1 Exit menu and save

- ⇒ Press the  button repeatedly until "END" appears.
- ⇒ Acknowledge by .

The balance returns automatically into weighing mode.

Selection available via  → and  button ↓

| Function | Settings | Description |
|---------------|--|--|
| SEtuP | | |
| Unit | on-off | Weighing unit kg |
| Grad | | |
| | 3000 d – 6000 d – 10000 d – 500 d – 1000 d – 1500 d - 2500 d - 2000 d | Partition steps, weighing range (max.) and readout (d) |
| Ut.-d | | |
| | Full – S-Ut | Selection Single-range (Full)- / Multiple-range balance (S-Ut) |
| FIIE | | |
| | Fast – Nor. - SLo | Filter: fast - normal - slow |
| Auto 0 | | |
| | 0.25 d – 0.5 d – 1 d – 3 d - OFF | Auto-Zero-Tracking |
| Stab | | |
| | 0.25 d – 0.5 d – 1 d – 3 d - off | Stabilisation range |
| Orang | | |
| | 2 Pct – 100 Pct. | Zero range: 2 % / 100 % |
| Ould | | |
| | 9 d – 2 Pct. | Overload range: 9 d / 2 % |
| CALib | | |
| | CAL-U – CAL-0 CAL-5 | Adjustment |
| A.Off | | |
| | 120s/180s/240s/ 300s/off | Automatic shutdown function |

| | | |
|----------------|---|--------------------------|
| burr | on/off | Audio signal |
| default | | Reset to default setting |
| End | Exit menu by pressing  | |

Description:

| | |
|--------------|---|
| Unit | Weighing unit: kg |
| GrAd | partition steps, weighing range (max.) and readout (d) |
| WE-d | Multi-range balance/ single-range balance selection |
| FULL | Single-range balance |
| S-WE | Multi-range balance |
| FILT | Filter: fast/ normal/ slow |
| Auto0 | Auto Zero Tracking: 0.25d / 0.5d / 1d / 3d / OFF |
| StAb | Stabilisation range: 0.25d / 0.5d / 1d / 3d / OFF |
| OrRng | Zero range: 2% / 100% |
| Overd | Overload range: 9d / 2% |
| CALib | Adjustment |
| ROFF | Auto off: 120 sec. / 180 sec. / 240 sec. / 300 sec. / OFF |
| bUrr | Audio signal: ON/OFF |
| dEFLt | Resetting to factory setting (Default setup) |
| End | Exit menu |

16.5 Verification validity period (current status in G)

| | |
|--|--------------|
| Personal weighing scales in hospitals | 4 years |
| Personal weighing scales if placed outside hospitals | without time |
| Baby and mechanical scales Infant scales | 4 years |
| Bed scales | 2 years |
| Wheelchair scales | 2 years |

The hospitals also include rehabilitation clinics and health centres (4-year validity of verification).

The hospitals do not include dialysis centres, care homes and consultation rooms (verification validity without time limit).

(Data on the basis: „Verification office informs, scales in medical applications”)